

CLASSIC

SINGLE HEAD ADJUSTABLE & FIXED OUTPUT PUMPS

The Classic Series metering pumps are a mechanical design, available in adjustable or fixed outputs. Typical installations include wired to a well pump pressure switch, activated by a water meter for proportional feed or with a controller.

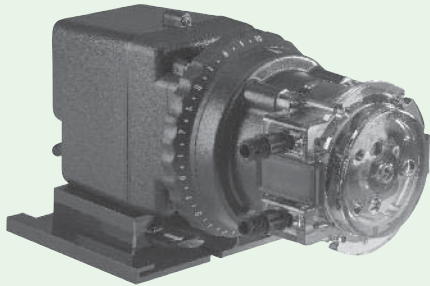

SINGLE HEAD ADJUSTABLE

The Classic Series single head adjustable metering pump is built with three detachable components; the motor, feed rate control, and the pump head. The output is determined by three factors; the rpm of the motor gears, the percentage setting on the feed rate control, and the size of the pump tube. The motor shaft rotates at a fixed rpm, which drives the feed rate control to intermittently engage the roller assembly within the pump head according to the setting on the external dial ring. The dial ring is labeled L to 10 and has a 20:1 turndown.

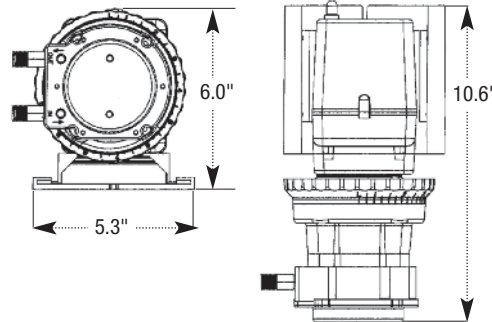

Shipping Weight 9 lbs (4 kg)
Box Dimensions 13 x 8 x 9 in. (33.0 x 20.4 x 22.9 cm)

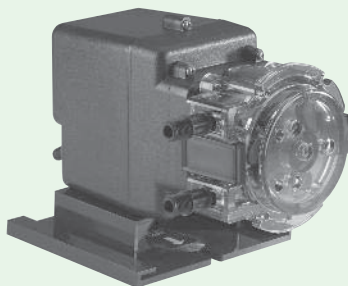

SINGLE HEAD FIXED OUTPUT

The Classic Series single head fixed output metering pump is built with two detachable components; the motor and the pump head. The fixed rate pump does not have an output adjustment. The output is determined by the rpm of the motor gears and the size of the pump tube. The motor's output shaft rotates at a fixed rpm which drives the roller assembly within the pump head.

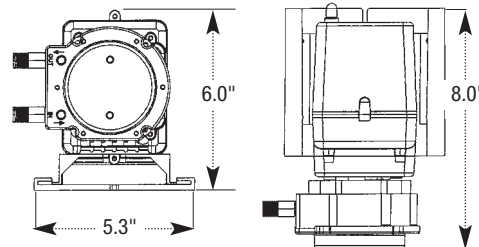

Shipping Weight 8 lbs (3.6 kg)
Box Dimensions 13 x 8 x 9 in. (33.0 x 20.4 x 22.9 cm)

Tank Systems are also available shipped pre-assembled for quick installations, refer to page 26.



The Classic Series Single Head Pumps are categorized into two sub-series, the 45 and 85.

45 SERIES

0.2 to 22.0 gpd up to 100 psi
0.2 to 50.0 gpd up to 25 psi

- 26 rpm
- Adjustable output 5%-100%, 2.5% increments
- Fixed output

85 SERIES

0.3 to 40.0 gpd up to 100 psi
0.3 to 85.0 gpd up to 25 psi

- 44 rpm
- Adjustable output 5%-100%, 2.5% increments
- Fixed output

The following pages display charts with pump output detail and are arranged by pressure rating.

Features

- 3-point roller design assists in anti-siphon protection
- Pump head requires no valves, allows for easy maintenance
- Self-priming against maximum working pressure, foot valve not required
- Pump does not lose prime or vapor lock
- Pumps off-gassing solutions and can run dry
- Output volume is not affected by back pressure
- Easy to change pump tube; lubrication is not required
- Pump tubes and pump heads interchange between models

Accessory Kit Shipped With Each Pump

- 3 connecting nuts 1/4" or 3/8"
- 3 ferrules 1/4" or 6 mm *EUROPE* OR 2 ferrules 3/8"
- 1 injection check valve 100 psi (6.9 bar) OR 1 injection fitting 25 psi (1.7 bar)
- 1 weighted suction line strainer 1/4", 3/8" or 6 mm *EUROPE*
- 1 20' roll suction/discharge tubing 1/4" or 3/8", white or UV black OR 6 mm white *EUROPE*
- 1 additional pump tube
- 2 additional latches
- 1 mounting bracket
- 1 manual

SPECIFICATIONS

Maximum Operating Temperature 125° F (52° C)

Maximum Suction Lift

25 ft (7.6 m) vertical lift, based on water

Motor Type 1/30 HP, shaded pole, class B

Duty Cycle Continuous

Motor Voltage (Amp Draw)

120V 60Hz 1PH (1.7)

220V 60Hz 1PH (0.9)

230V 50Hz 1PH (0.9) *INTERNATIONAL*

250V 50Hz 1PH (0.9) *INTERNATIONAL*

Power Cord Type SJTOW

Power Cord Plug End

120V 60Hz NEMA 5/15

220V 60Hz NEMA 6/15

230V 50Hz CEE 7/II

250V 50Hz CEE 7/II

MATERIALS OF CONSTRUCTION

All Housings Polycarbonate

Pump Tube & Check Valve Duckbill Santoprene®, optional Tygothane®** #1, #2 & #5 tubes, FDA approved

CV Duckbill with Tygothane® Tube** Pellathane®†

Pump Head Rollers HDPE

Roller Bushings Oil impregnated sintered bronze

Suction/Discharge Tubing, Ferrules 1/4" & 6 mm Polyethylene, FDA approved

Tube Fittings, Check Valve Fittings

Gray fittings: Type 1 Rigid PVC, NSF listed

Black fittings: PP, NSF listed

Connecting Nuts PP or Type 1 Rigid PVC

3/8" Adapter Type 1 Rigid PVC, NSF listed

Suction Line Strainer PP or Type 1 Rigid PVC body with Type 1 Rigid PVC cap, NSF listed; ceramic weight

All Fasteners Stainless steel

Pump Head Latches Polypropylene

AGENCY LISTINGS

- Models tested by Water Quality Association to conform to ANSI/NSF STD 61 (Santoprene® only)
- Adjustable models tested by ETL to conform to ANSI/NSF STD 50 (Santoprene® only)
- Listings vary by model

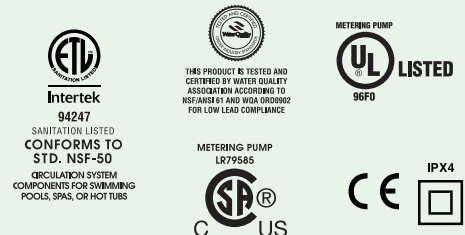

* Santoprene® is a registered trademark of Exxon Mobil Corporation.

** Tygothane® is a registered trademark of Saint-Gobain Performance Plastics.

† Pellathane® is a registered trademark of The Dow Company.

CLASSIC

SINGLE HEAD ADJUSTABLE OUTPUT PUMP 26-100 psi (1.8-6.9 bar)

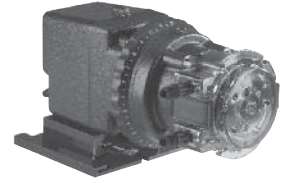

OUTPUT

Model	Item Number Prefix	Pump Tube Number	Gallons per Day	Liters per Day	Gallons per Hour	Liters per Hour	Ounces per Minute	Milliliters per Minute	Liters per Day	Liters per Hour	Milliliters per Minute	
45 SERIES	45MHP2	45MJH1	#1	0.2 to 3.0	0.8 to 11.4	0.01 to 0.13	0.03 to 0.48	0.02 to 0.27	0.56 to 7.92	0.6 to 9.1	0.02 to 0.38	0.31 to 6.32
	45MHP10	45MJH2	#2	0.5 to 10.0	1.9 to 37.9	0.02 to 0.42	0.08 to 1.58	0.04 to 0.89	1.32 to 26.32	1.5 to 30.3	0.06 to 1.26	1.04 to 21.04
	45MHP22	45MJH7	#7	1.1 to 22.0	4.2 to 83.3	0.05 to 0.92	0.18 to 3.47	0.10 to 1.96	2.92 to 57.85	3.3 to 66.6	0.14 to 2.78	2.29 to 46.25
85 SERIES	85MHP5	85MJH1	#1	0.3 to 5.0	1.1 to 18.9	0.01 to 0.21	0.05 to 0.79	0.03 to 0.44	0.76 to 13.13	0.9 to 15.1	0.04 to 0.63	0.52 to 10.49
	85MHP17	85MJH2	#2	0.8 to 17.0	3.0 to 64.4	0.03 to 0.71	0.13 to 2.68	0.07 to 1.51	2.08 to 44.65	2.4 to 51.5	0.10 to 2.15	1.67 to 35.76
	85MHP40	85MJH7	#7	2.0 to 40.0	7.6 to 151.4	0.08 to 1.67	0.32 to 6.31	0.18 to 3.55	5.27 to 105.14	6.1 to 121.1	0.25 to 5.05	4.24 to 84.10
Approximate Output @ 60Hz									Approximate Output @ 50Hz			

NOTE: Injection check valve included with pumps rated 26-100 psi (1.8-6.9 bar).

NOTICE: The information within this chart is solely intended for use as a guide. The output data is an approximation based on pumping water under a controlled testing environment. Many variables can affect the output of the pump. Stenner Pump Company recommends that all metering pumps undergo field calibration by means of analytical testing to confirm their outputs.

BUILD AN ITEM NUMBER

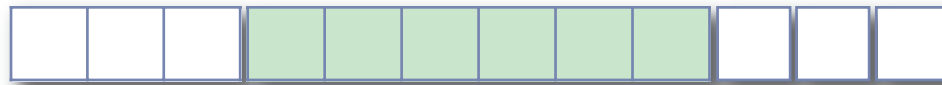

Select **Item Number Prefix** from output chart above

Leave blank if not ordering a tank system

Tank

- S7G** 7.5-Gallon UV Gray
- S7N** 7.5-Gallon White
- S1G** 15-Gallon UV Gray
- S1N** 15-Gallon White
- S3G** 30-Gallon UV Gray
- S3N** 30-Gallon White

NOTE: Tanks also sold separately on page 27.

Voltage & Hertz

- A** 120V 60Hz
- B** 220V 60Hz
- C** 230V 50Hz, CEE7 Cord *INTERNATIONAL*
- D** 250V 50Hz, CEE7 Cord *INTERNATIONAL*

NOTE: Contact the factory for additional voltage and cord options.

Suction & Discharge Tubing

- 1** 1/4" White
- 2** 1/4" UV Black
- 3** 3/8" White
- 4** 3/8" UV Black
- 5** 6 mm White *EUROPE*

NOTE: O.D. does not affect output.

Tube Material

- S** Santoprene®
- T** Tygothane® (#1 & 2 only)

NOTE: Application specific, refer to chemical resistance guide for chemical compatibility.

Example



Pump Item Number: 85MJH2A1S

- 85MHP17 Pump
- 120V 60Hz
- 1/4" White Suction & Discharge Tubing
- Santoprene® Tube